

Name: _____ Date: _____

Writing Numbers Learn To Write: One

Say It. Write It. Repeat It!

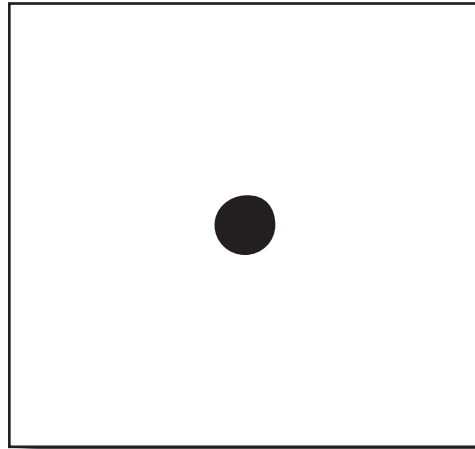
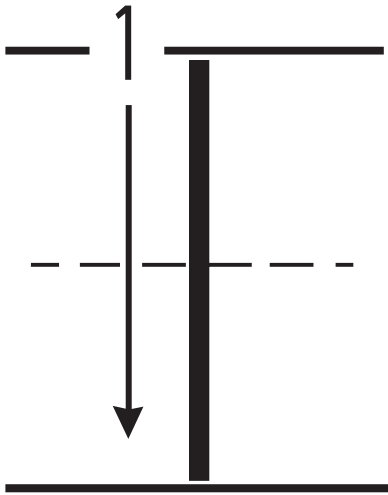

Three sets of handwriting lines. Each set consists of a solid top line, a dashed middle line, and a solid bottom line. The first set has three vertical lines drawn from the top line to the bottom line, starting from the left side. The second and third sets are blank for practice.

Draw 1 Toy

Name: _____ Date: _____

Writing Numbers Learn To Write: Two

Say It. Write It. Repeat It!

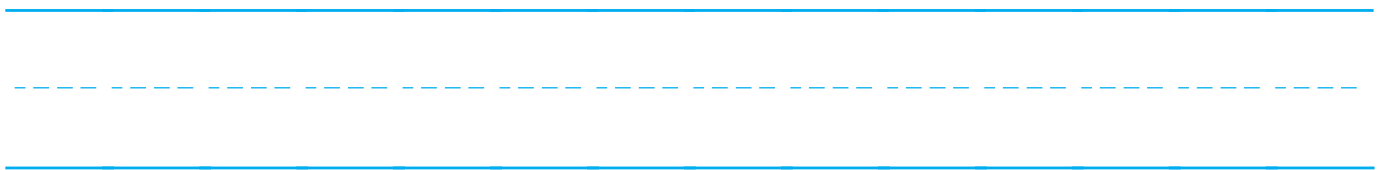
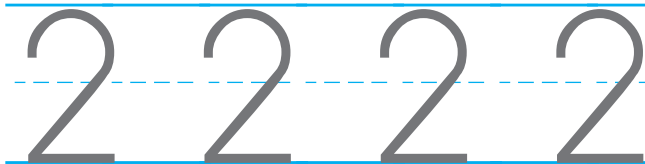
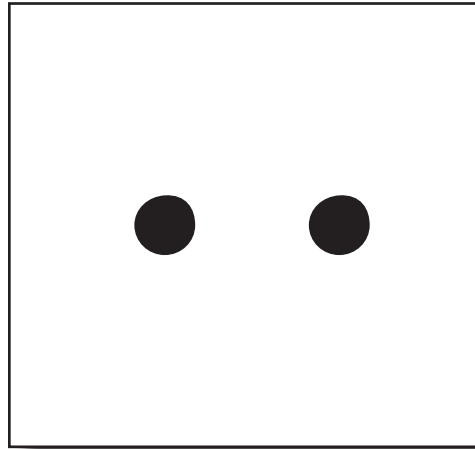
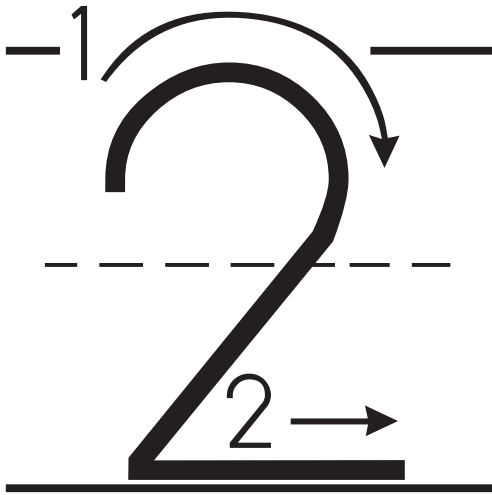

Draw 2 Toys

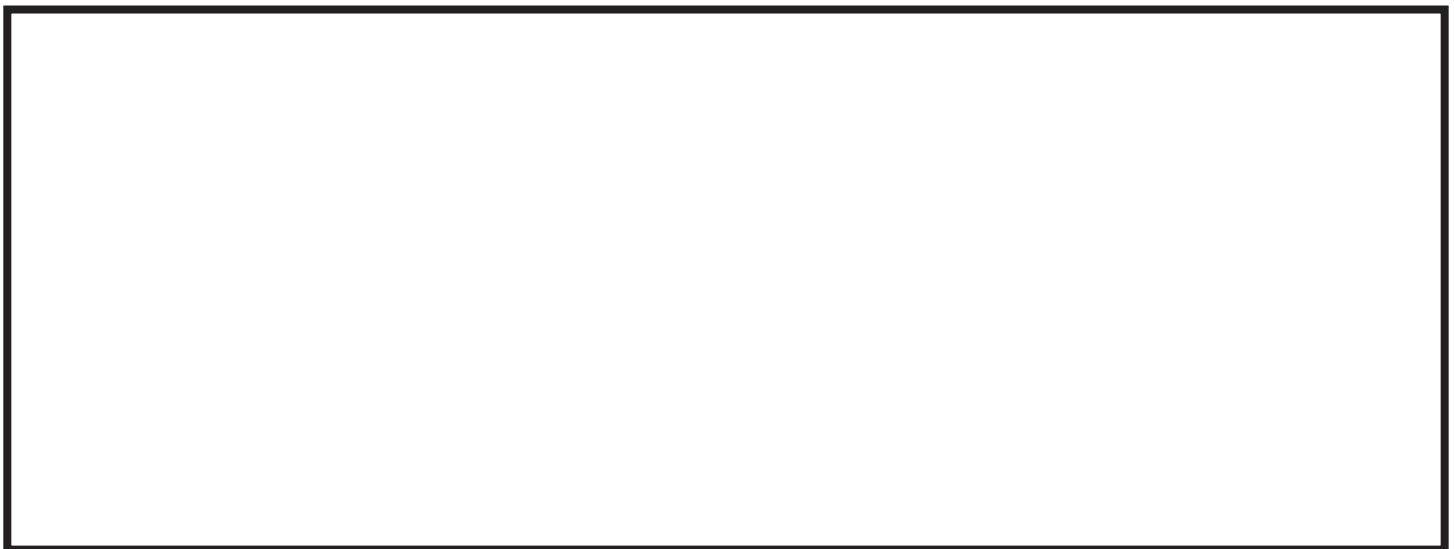

Name: _____

Date: _____

Writing Numbers Learn To Write: Three

Say It. Write It. Repeat It!

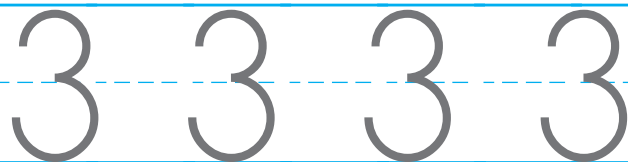
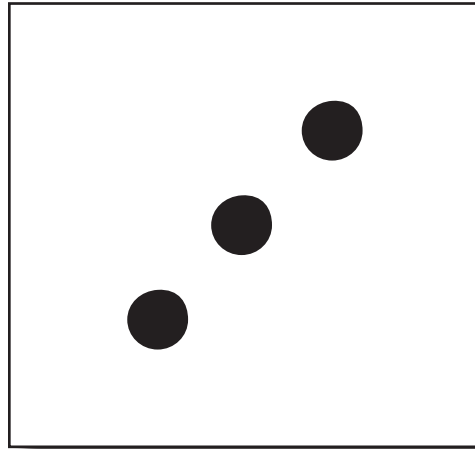
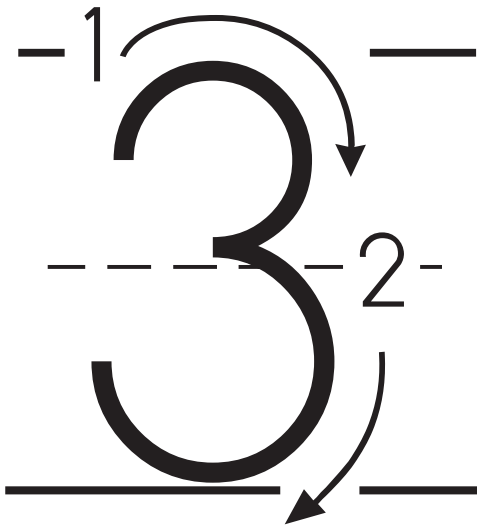

Draw 3 Toys

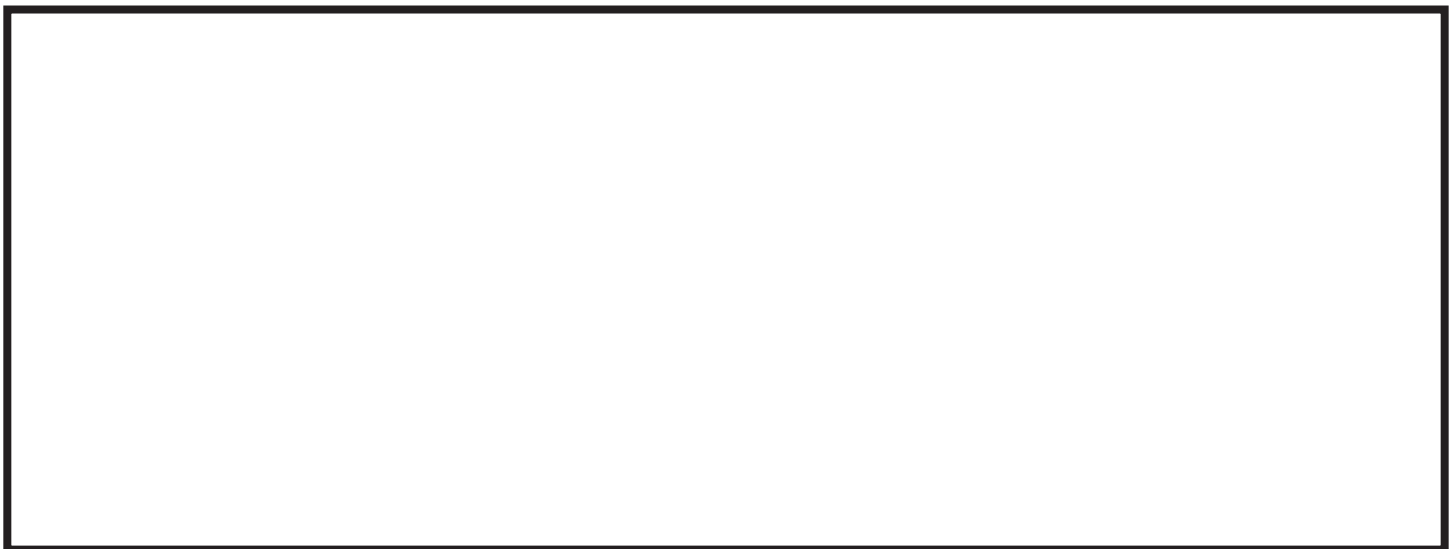

Name: _____ Date: _____

Writing Numbers Learn To Write: Four

Say It. Write It. Repeat It!

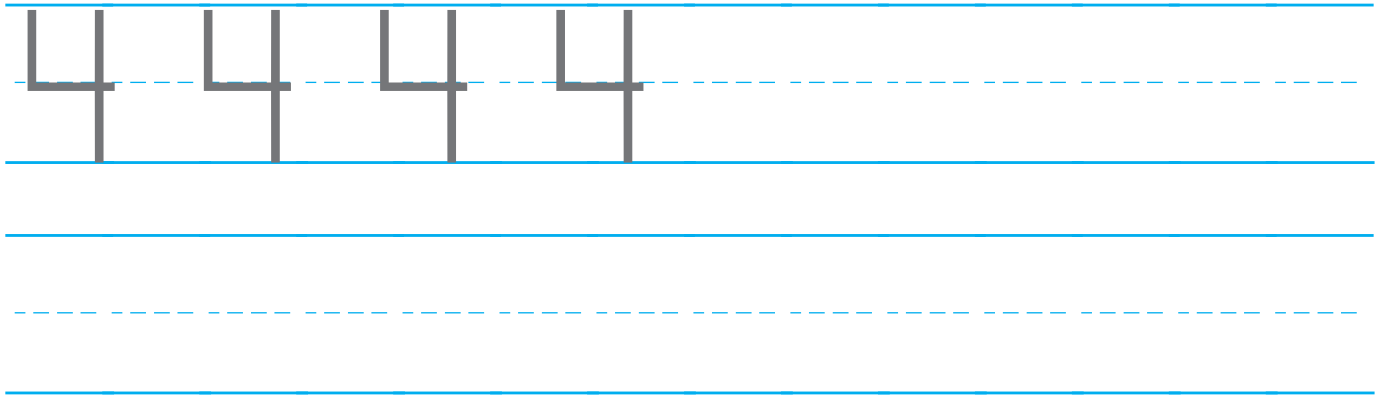
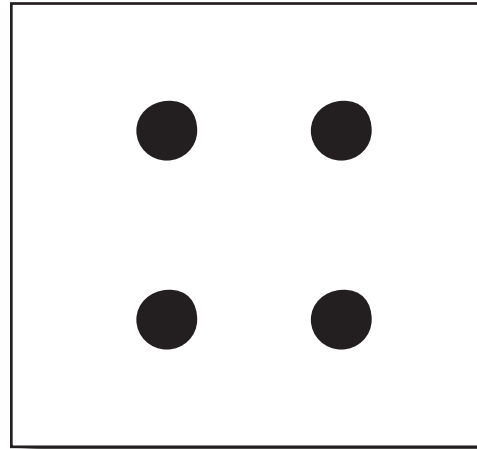
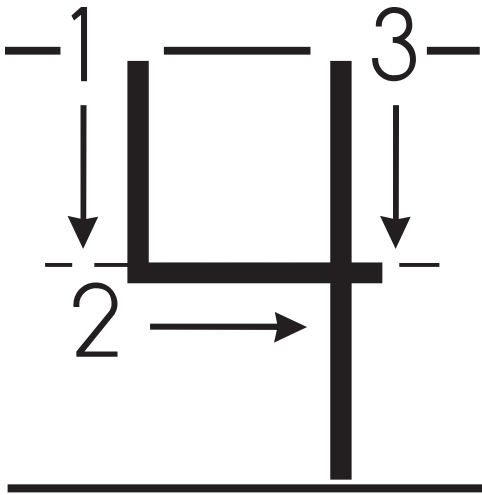

Draw 4 Toys

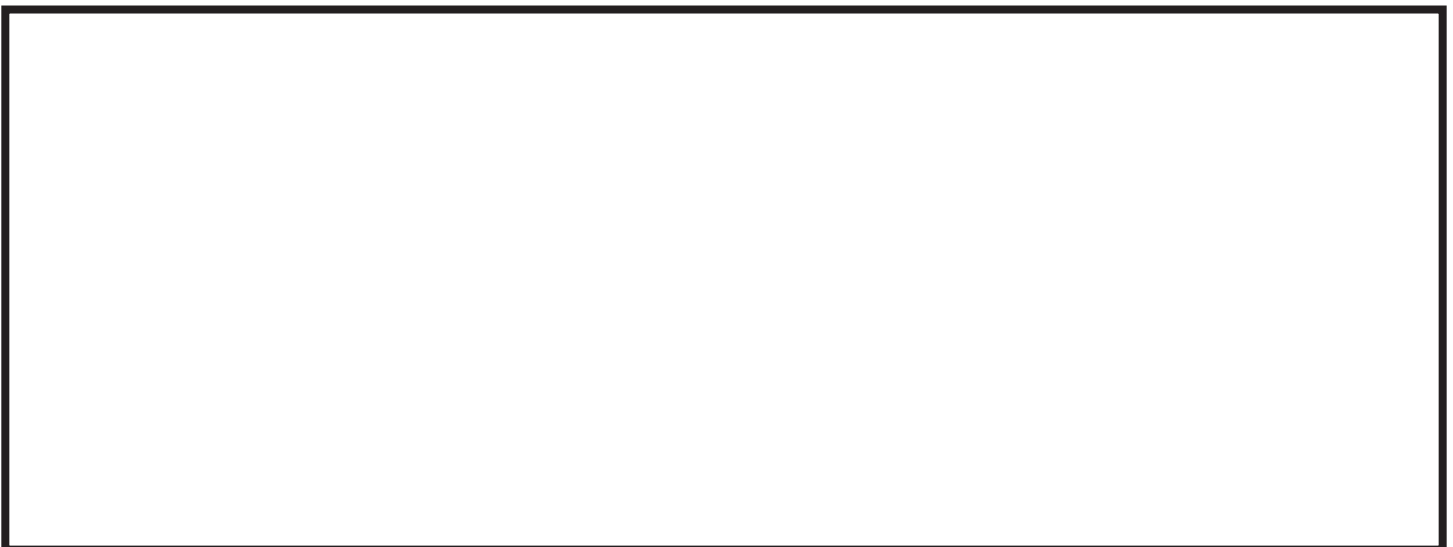

Name: _____

Date: _____

Writing Numbers Learn To Write: Five

Say It. Write It. Repeat It!

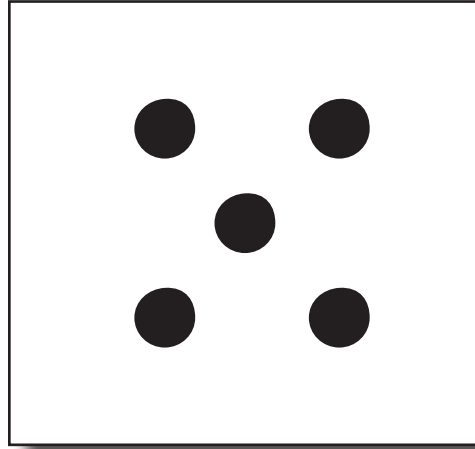
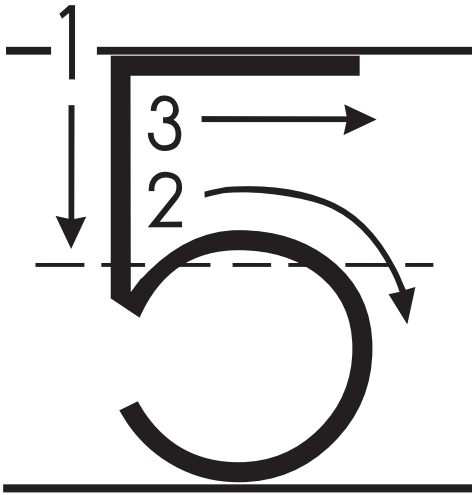

Draw 5 Toys

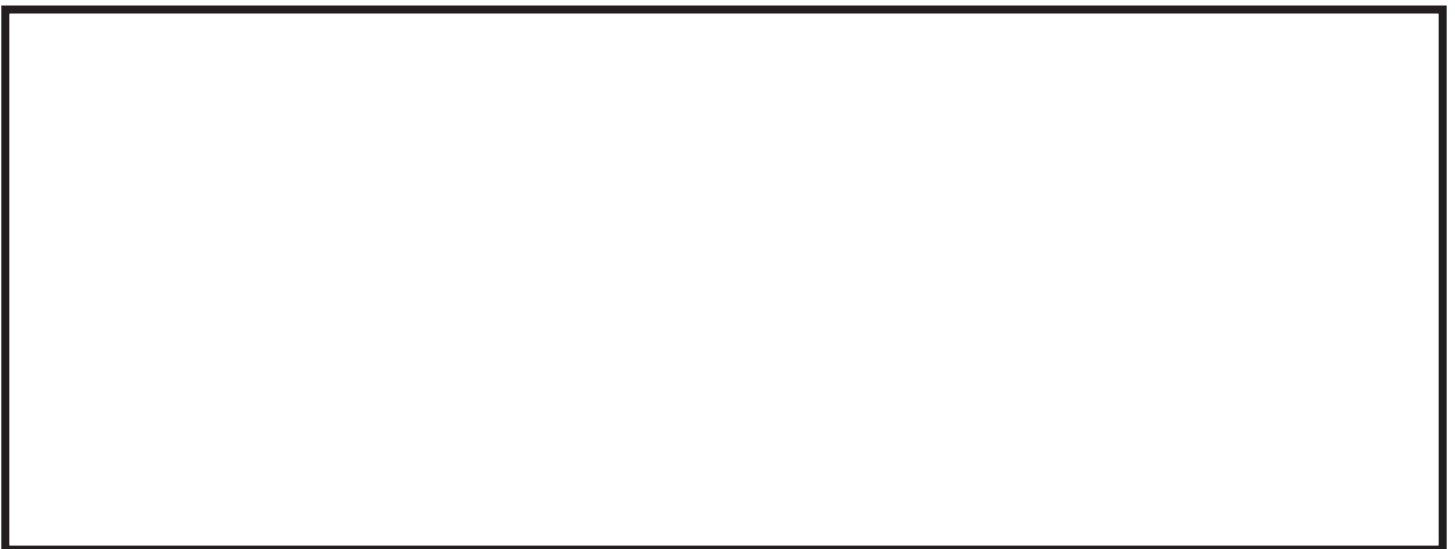

Name: _____ Date: _____

Writing Numbers Learn To Write: Six

Say It. Write It. Repeat It!

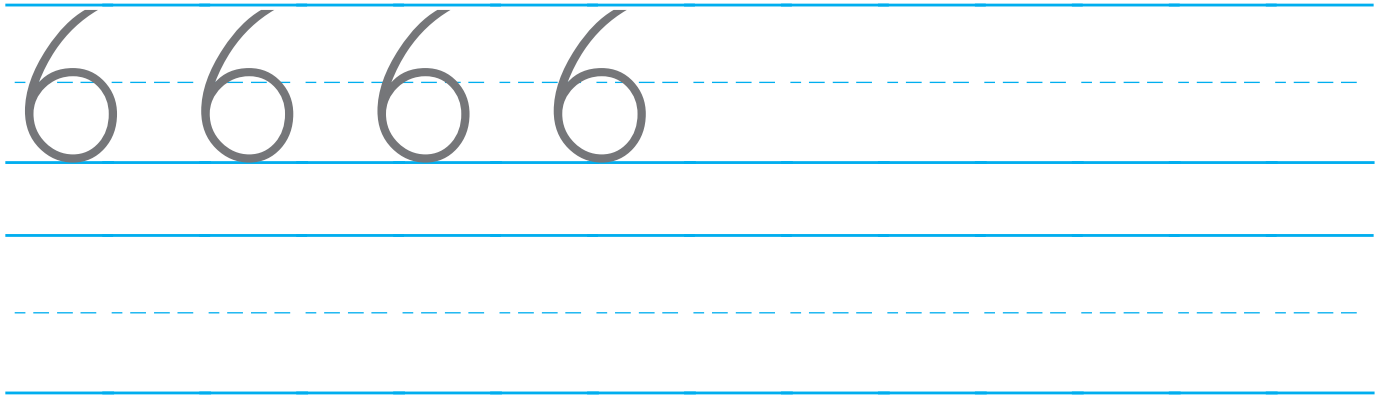
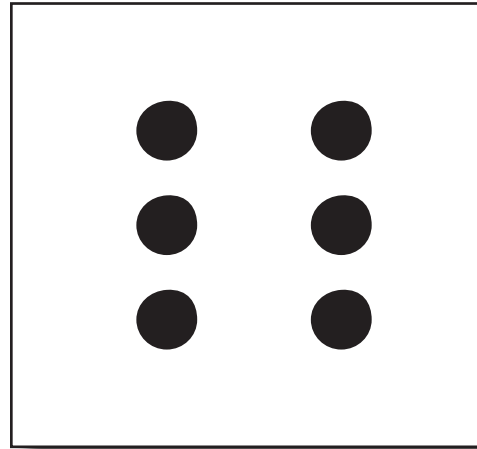
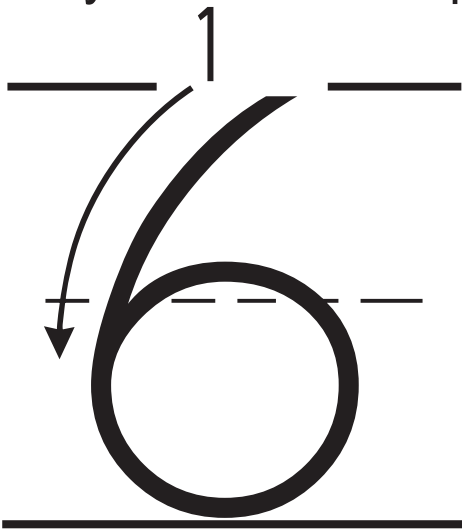

Draw 6 Toys

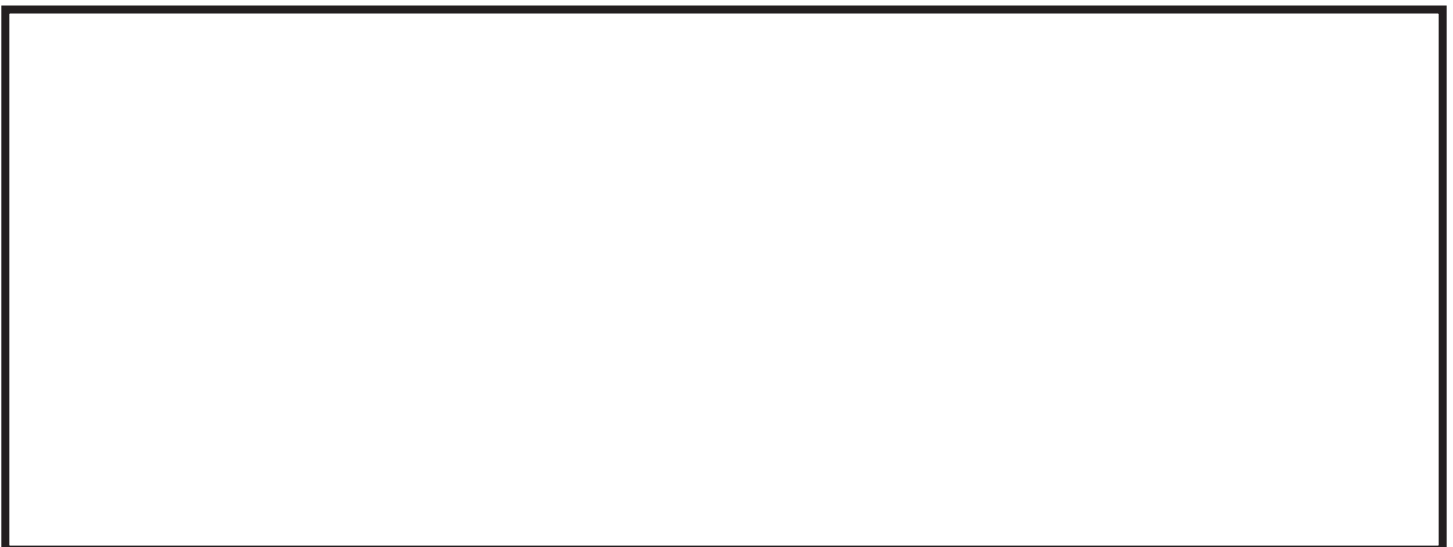

Name: _____ Date: _____

Writing Numbers Learn To Write: Seven

Say It. Write It. Repeat It!

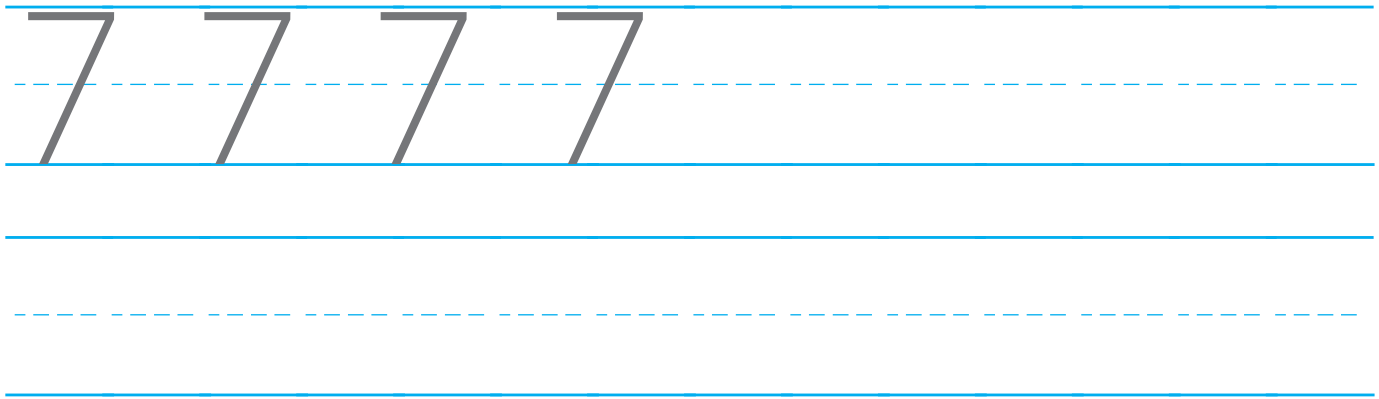
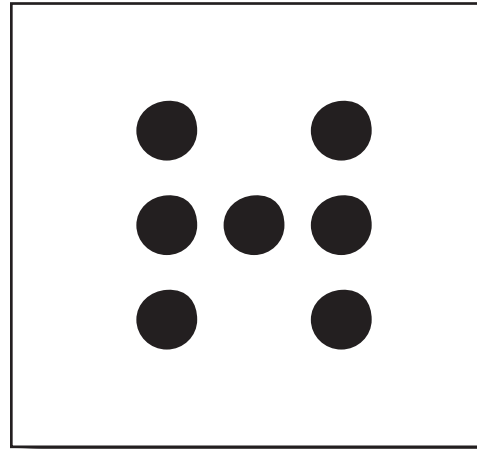
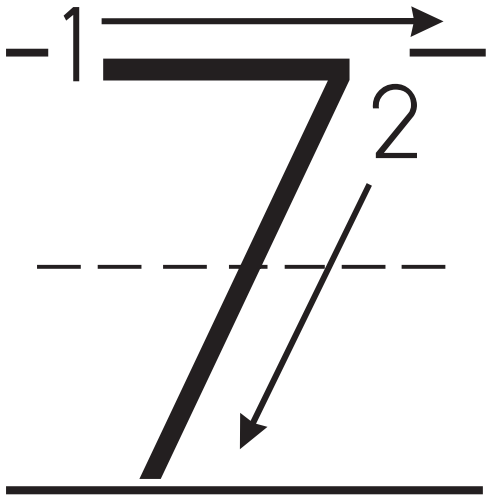

Draw 7 Toys

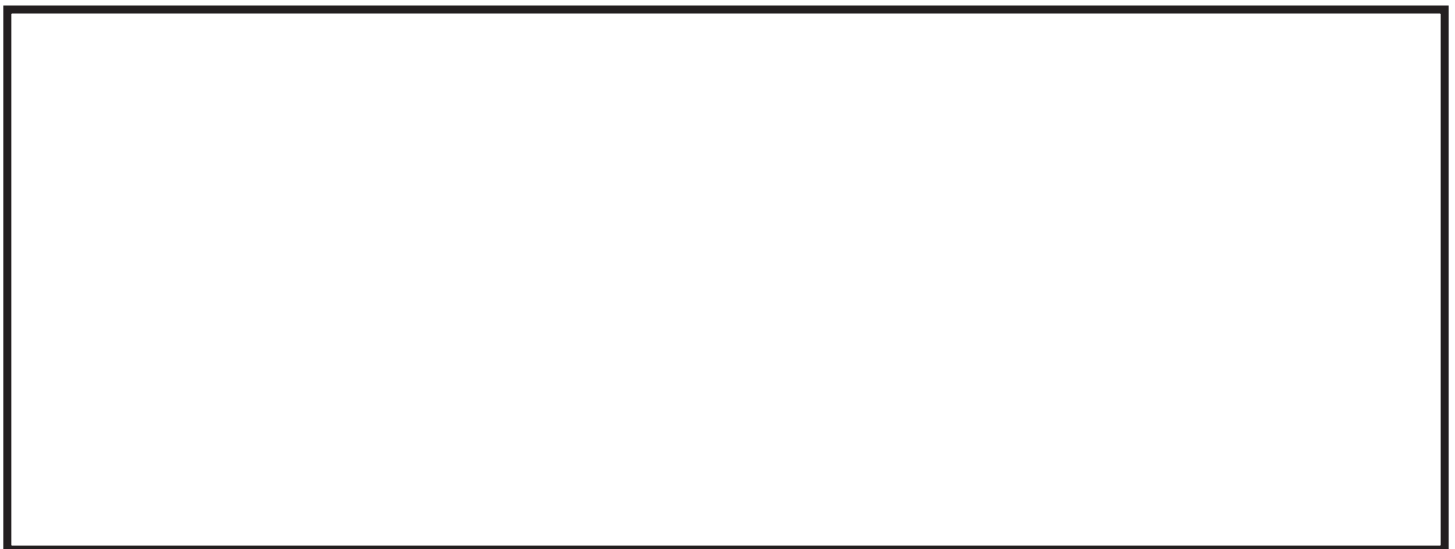

Name: _____

Date: _____

Writing Numbers Learn To Write: Eight

Say It. Write It. Repeat It!

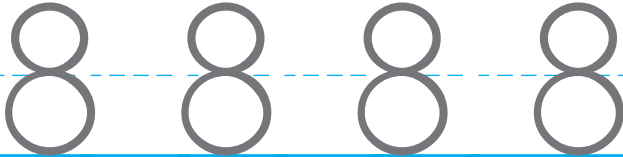
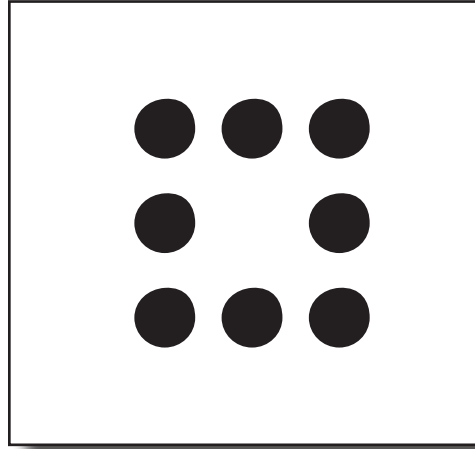
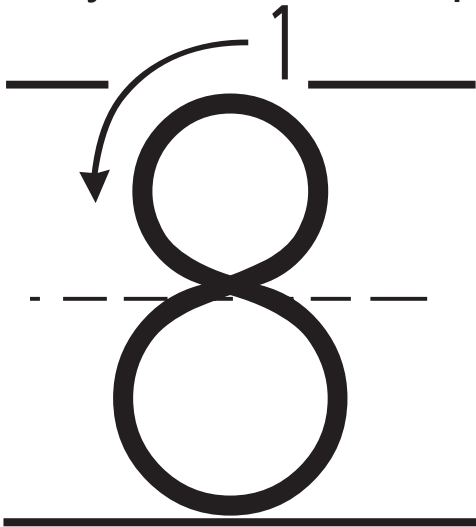

Draw 8 Toys



Name: _____ Date: _____

Writing Numbers Learn To Write: Nine

Say It. Write It. Repeat It!

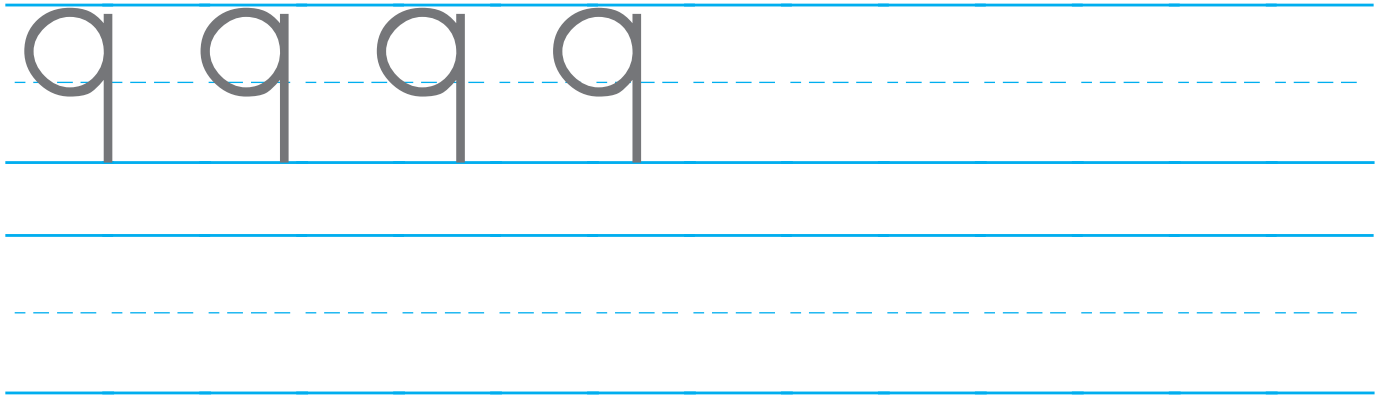
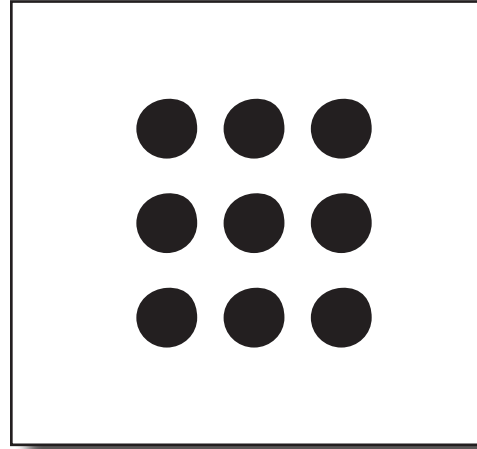
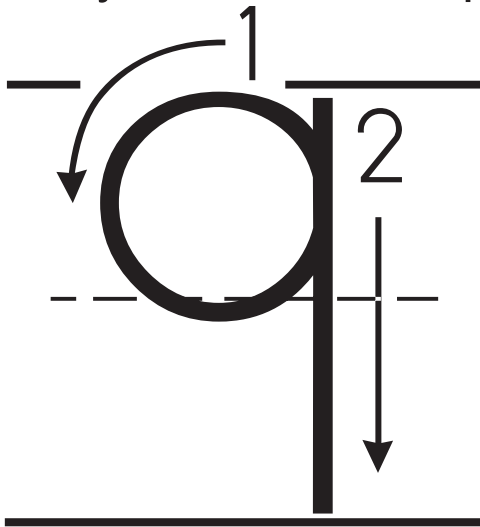

Draw 9 Toys

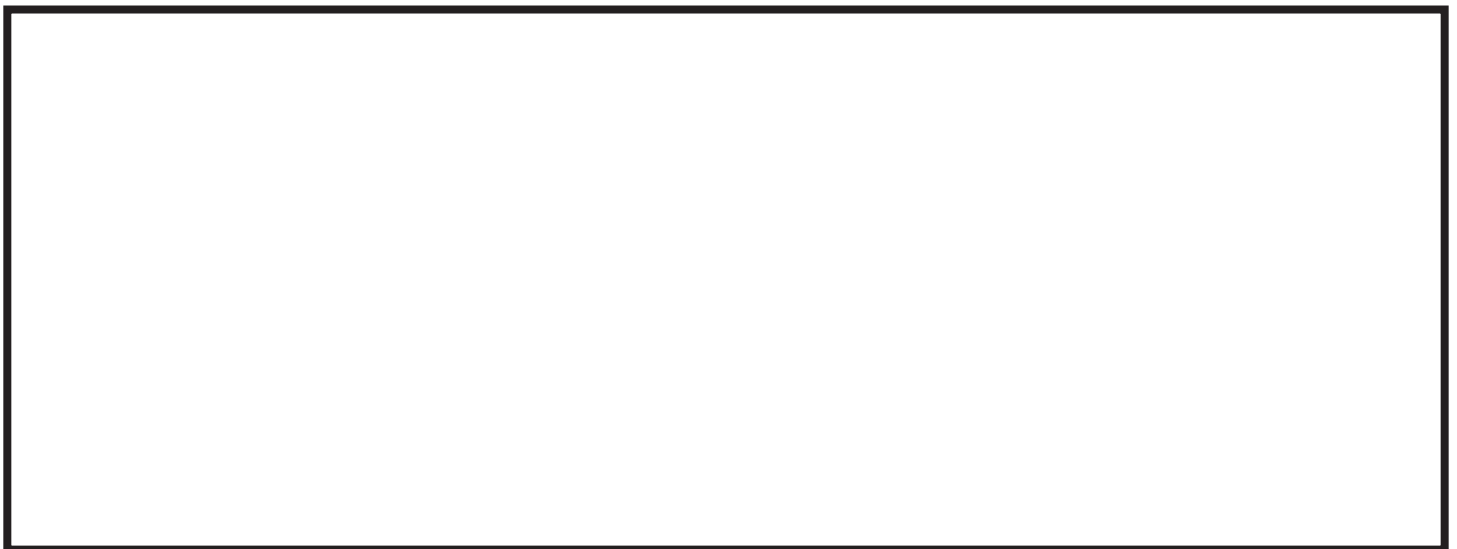

Name: _____ Date: _____

Writing Numbers Learn To Write: Ten

Say It. Write It. Repeat It!

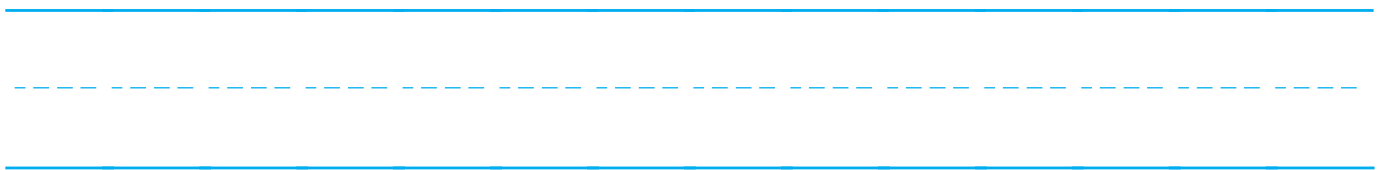
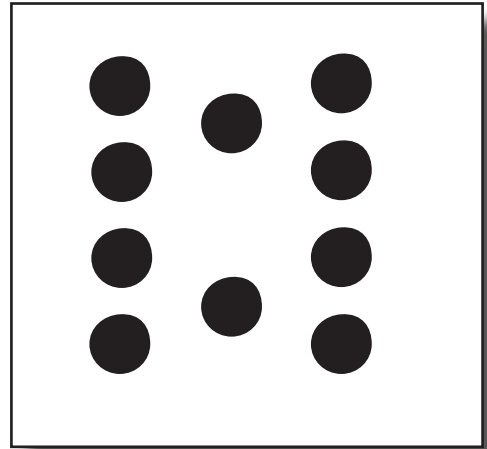
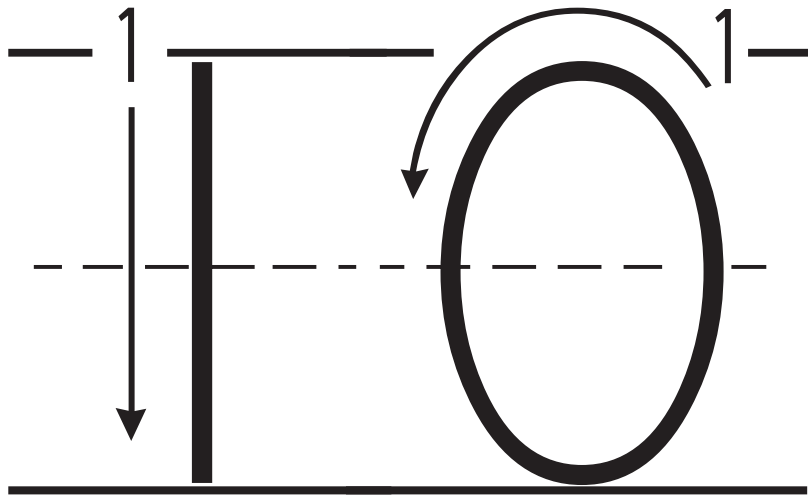

Draw 10 Toys

